

LB-34-15-C-KF Standard Gain Horn Antenna 22-33GHz 15dB Gain
2.92mm Female

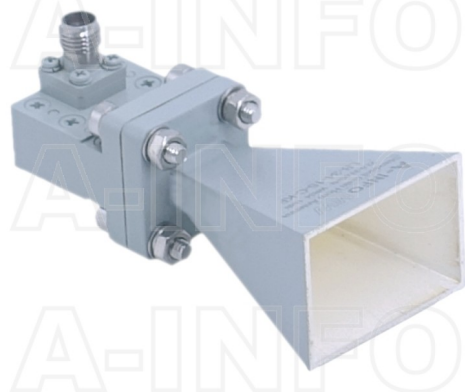

Standard Gain Horn Antenna Operating From 22GHz to 33GHz With a Nominal 15dB Gain With 2.92mm Female Connector

Product Information

SKU	LB-34-15-C-KF
-----	---------------

Description

Standard Gain Horn Antenna LB-34-15-C-KF, operating from 22 to 33GHz with a nominal 15dB gain and low VSWR 1.25:1 with 2.92mm Female connector output. The model LB-34-15-C-KF has uniform gain through its frequency span, providing efficient performance characteristics and directionality. It can handle 20W continuously and 40W peak power. Constructed of lightweight corrosion-resistant aluminum, the antenna will provide years of trouble-free indoor and outdoor service. This standard gain horn antenna is linearly polarized and ideally suited for EMI testing, direction finding, surveillance, antenna gain and pattern measurements and other applications.

Technical Specification

Electrical Specification		Interface	
Frequency, Min (GHz)	22	Output Type	Coaxial
Frequency, Max (GHz)	33	Connector	2.92mm(K)
Waveguide Type	Rectangular	Connector Gender	Female
Waveguide Size EIA WR	WR34	Mechanical Specification	
Gain, Typ (dBi)	15	Figure	C Type
Polarization	Linear	Body Material	Cu
3dB Beamwidth, E-Plane, Typ (Deg.)	26	Finish	Gold Plated and Silver Plated, Gray Paint
3dB Beamwidth, H-Plane, Typ (Deg.)	25	Size, W (mm)	31
Cross Pol. Isolation, Typ (dB)	40	Size, H (mm)	27.6
VSWR, Typ	1.25:1	Size, L (mm)	66
Impedance, (Ohm)	50	Weight, (kg)	0.1
Power Handling, CW, (W)	20		
Power Handling, Peak, (W)	40		

Additional Information

Application	General Purpose Indoor & Outdoor, Fixed	Solution for	Gain Reference Antenna Measurement Reflector Feed Far-field Measurement System Intergration Material Measurement
-------------	---	--------------	---

Outline Drawing

2.92mm-Female Output (P/N: LB-34-15-C-KF)

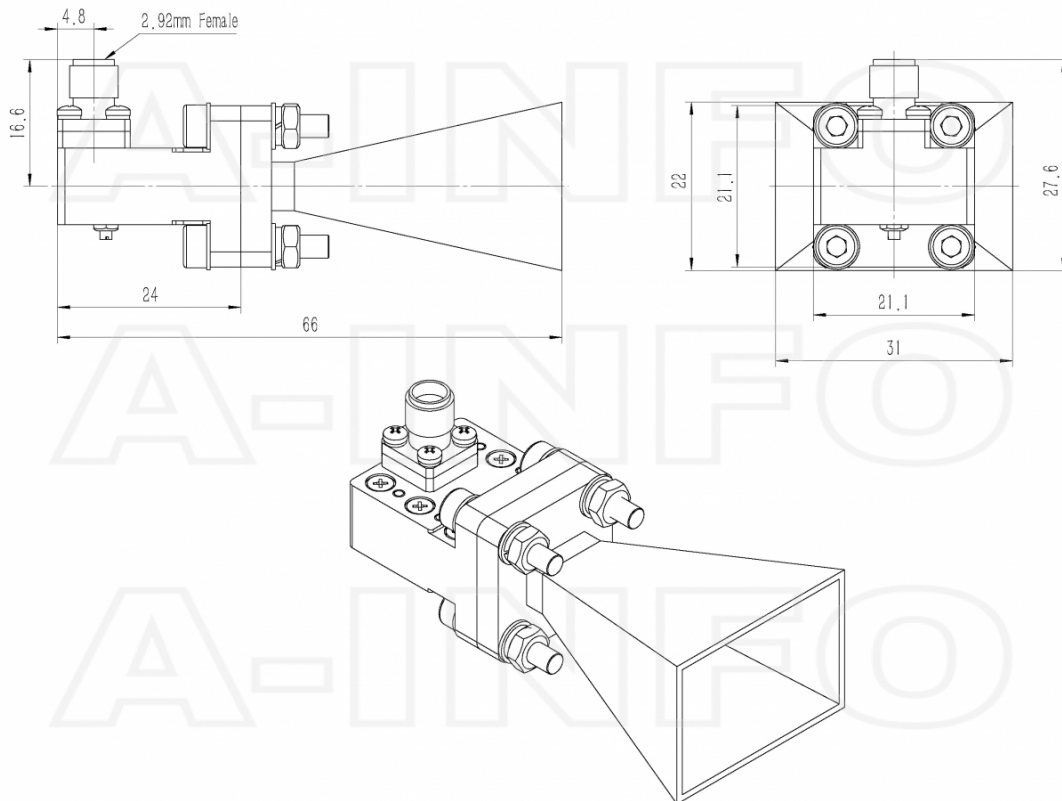

2.92mm-Female Output with Round Mounting Bracket (Option, P/N: LB-34-10-C-MB)

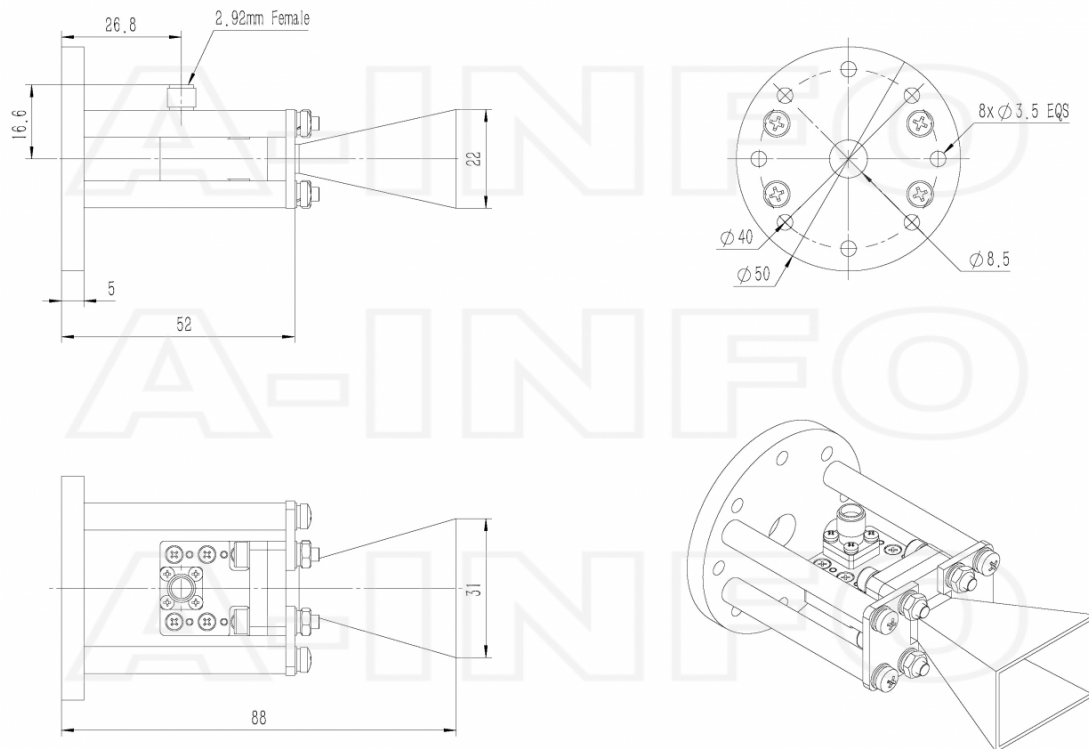

2.92mm-Female Output with L Type Mounting Bracket (Option, P/N: LB-34-10-C-MBL)

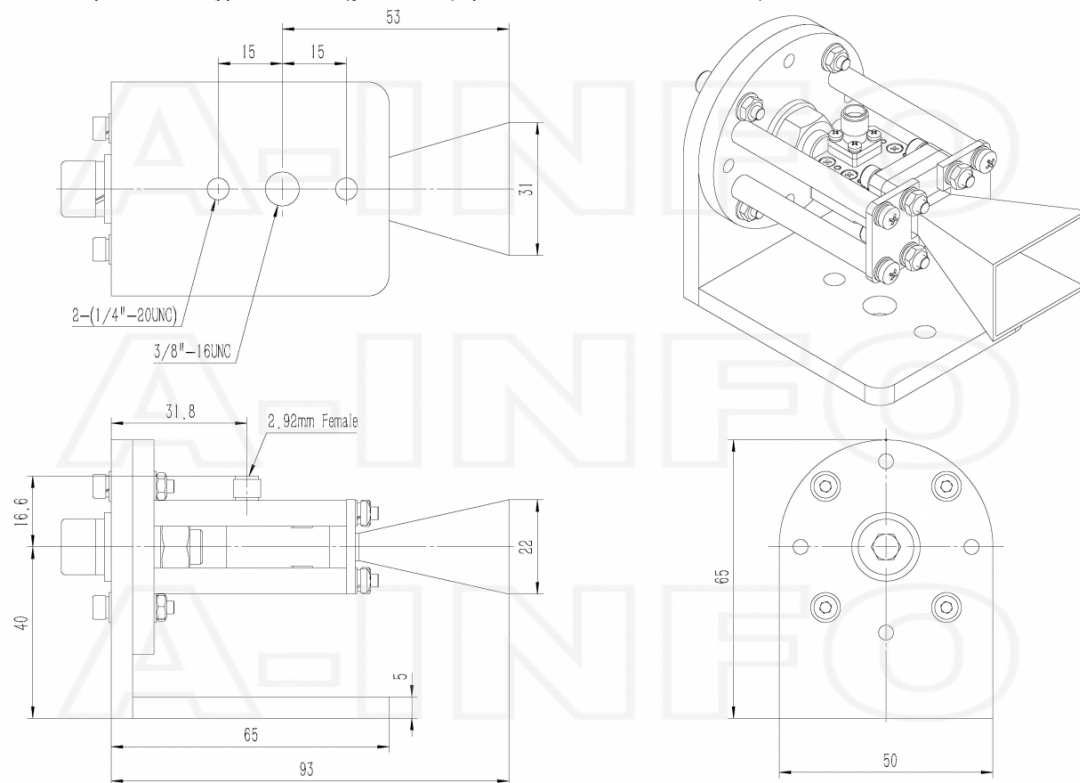

Typical Test Results

Gain

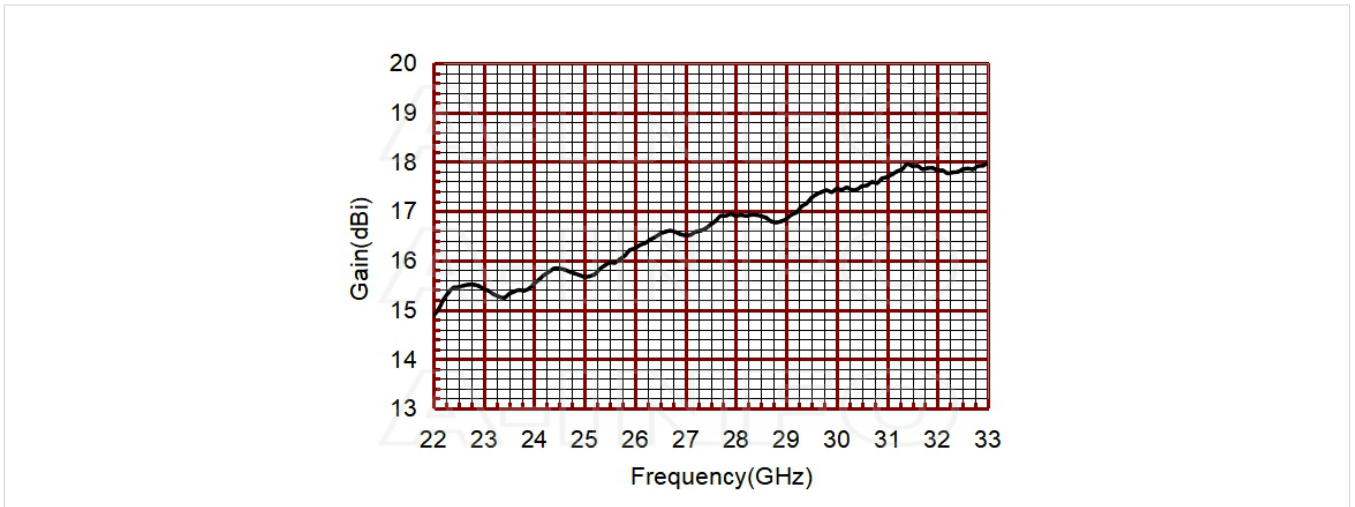

Antenna Factor

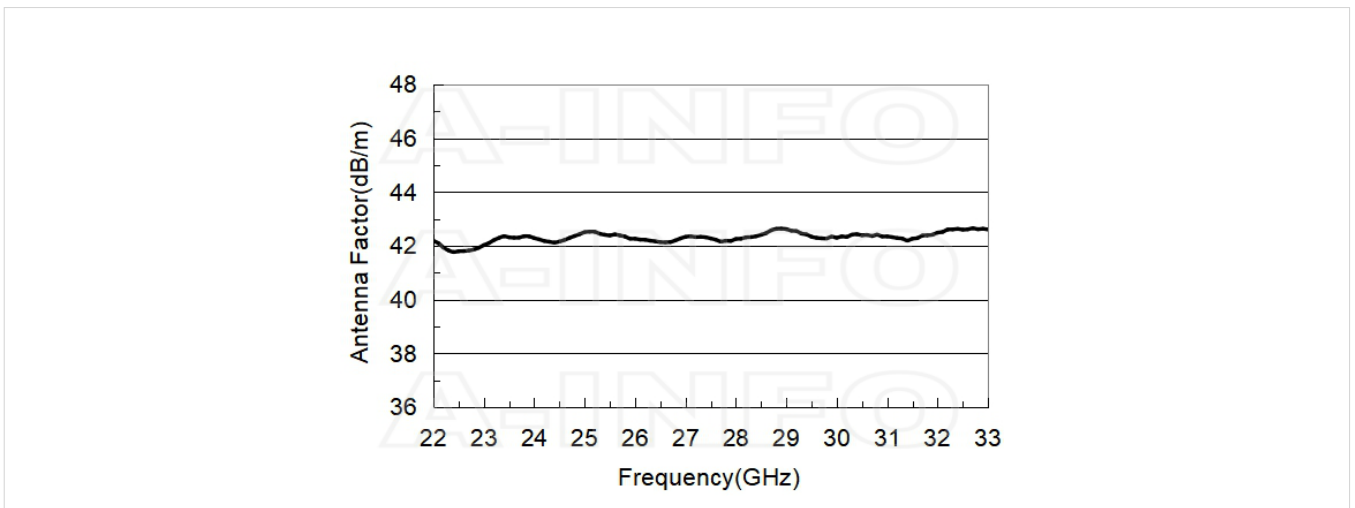

Antenna Factor (Table)

Frequency (GHz)	Gain (dBi)	Antenna Factor (dB/m)	Frequency (GHz)	Gain (dBi)	Antenna Factor (dB/m)
22.00	14.87	42.19	28.00	16.90	42.25
22.50	15.46	41.80	28.50	16.90	42.41
23.00	15.42	42.02	29.00	16.84	42.62
23.50	15.32	42.32	29.50	17.27	42.34
24.00	15.53	42.29	30.00	17.45	42.30
24.50	15.84	42.16	30.50	17.50	42.39
25.00	15.66	42.51	31.00	17.69	42.35
25.50	15.95	42.39	31.50	17.91	42.26
26.00	16.25	42.26	32.00	17.82	42.49
26.50	16.54	42.14	32.50	17.85	42.60
27.00	16.51	42.33	33.00	17.97	42.61
27.50	16.72	42.27			

Cross Polarization Isolation

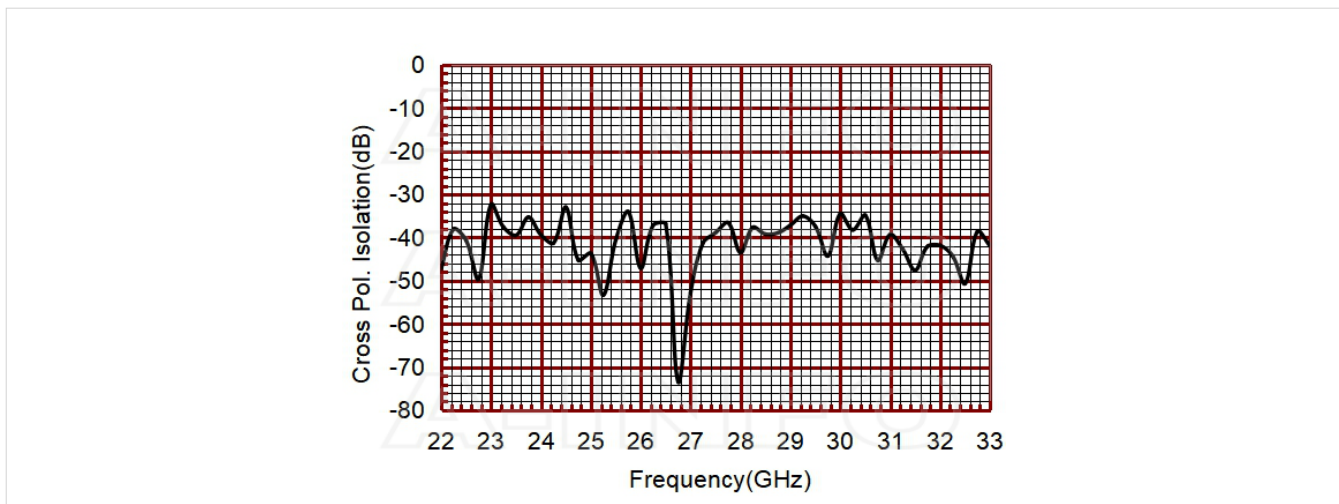

VSWR

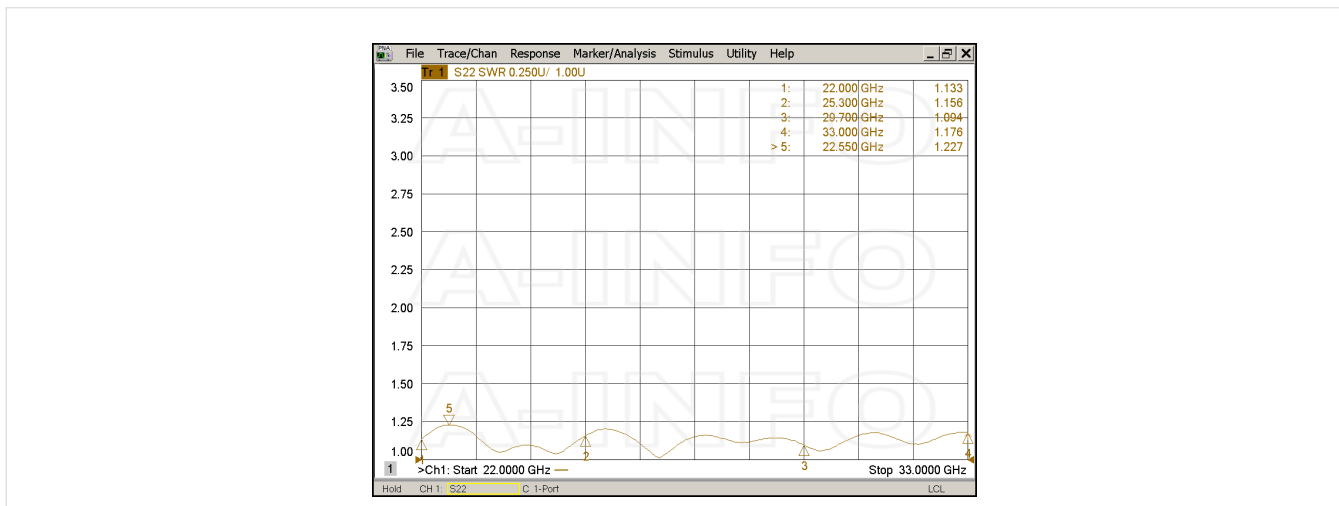

Pattern

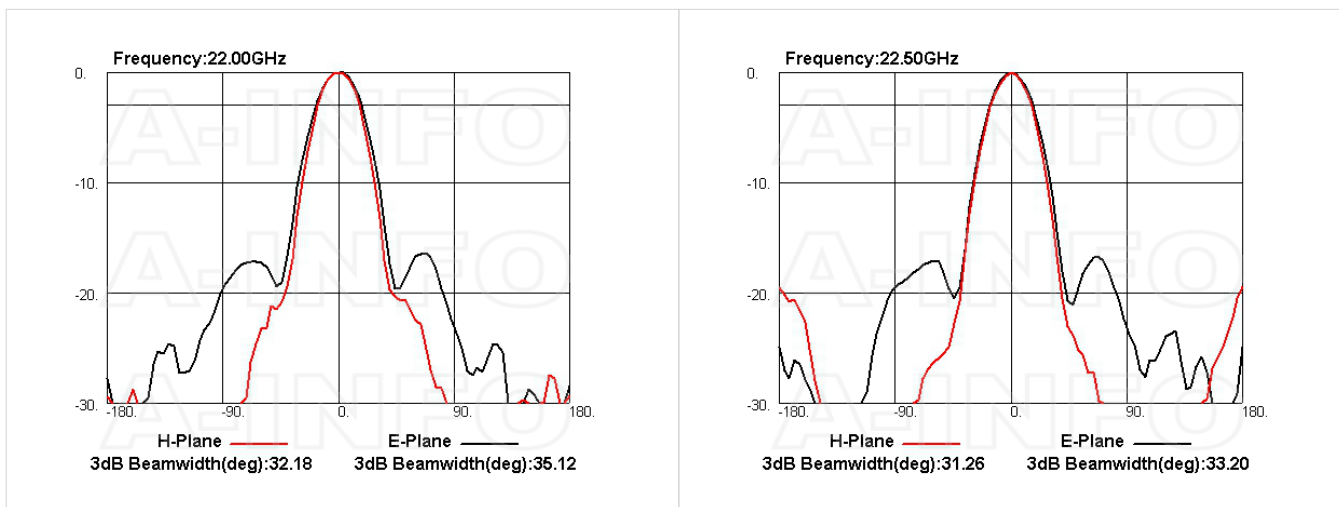

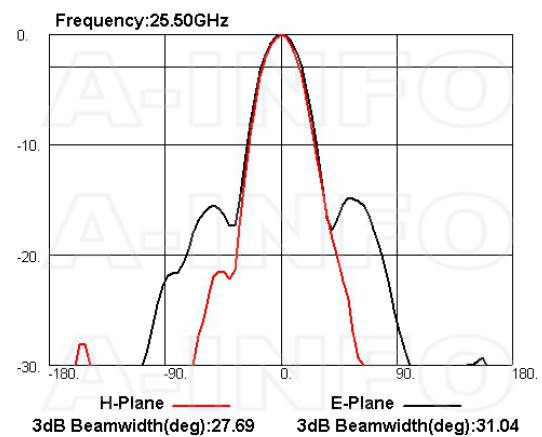
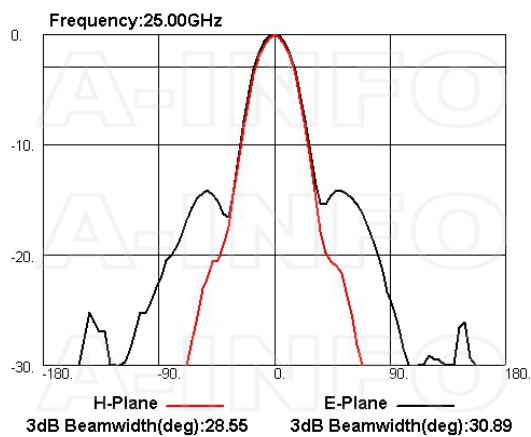
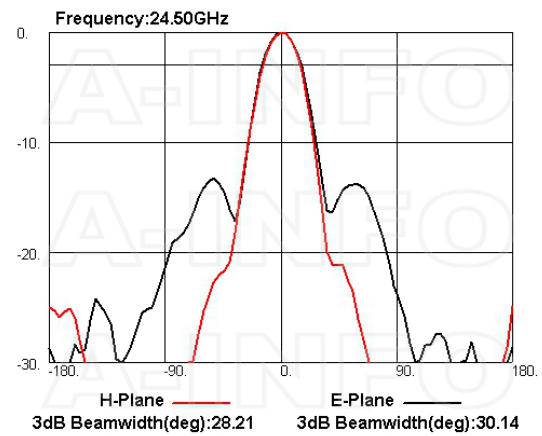
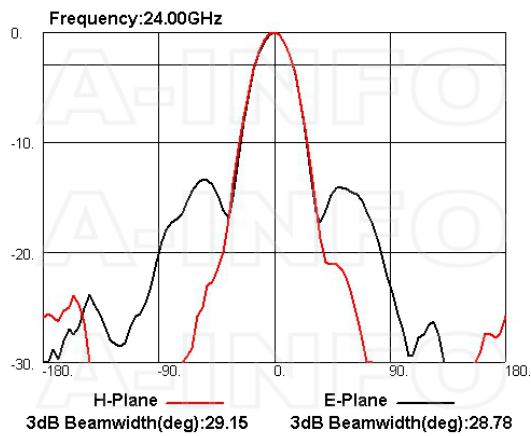
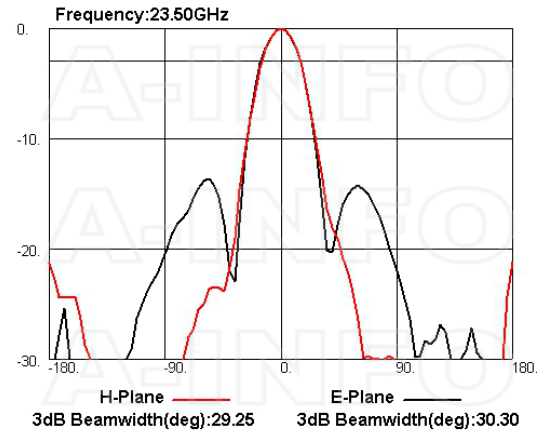
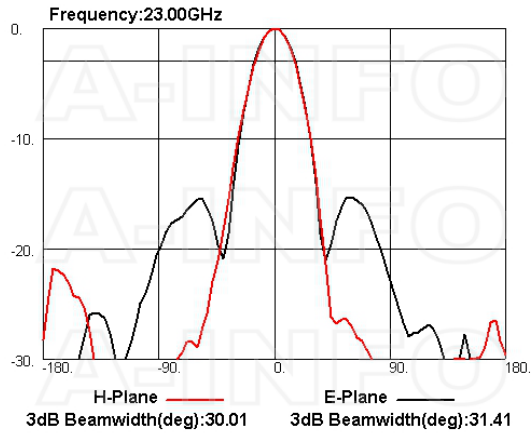

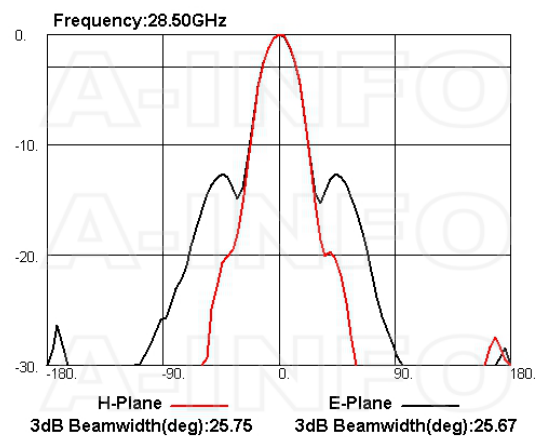
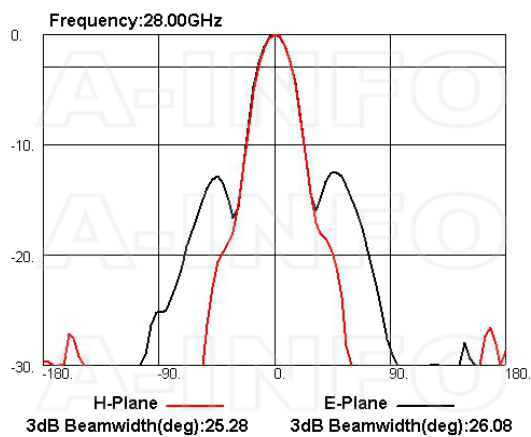
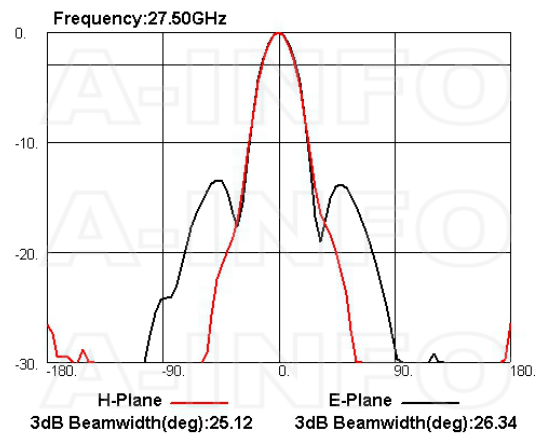
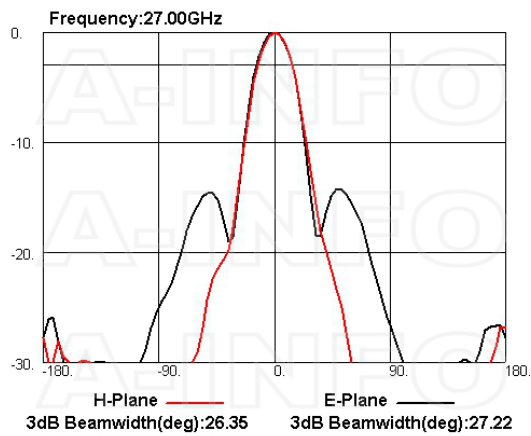
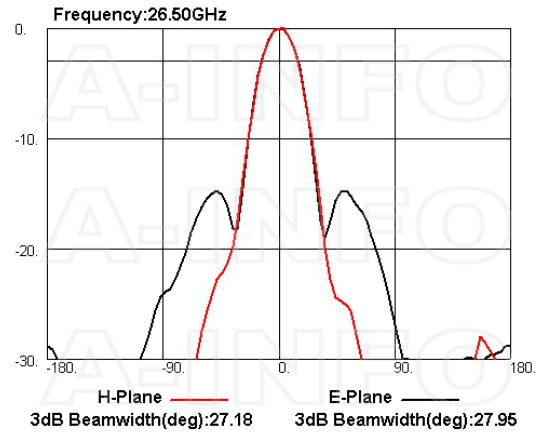
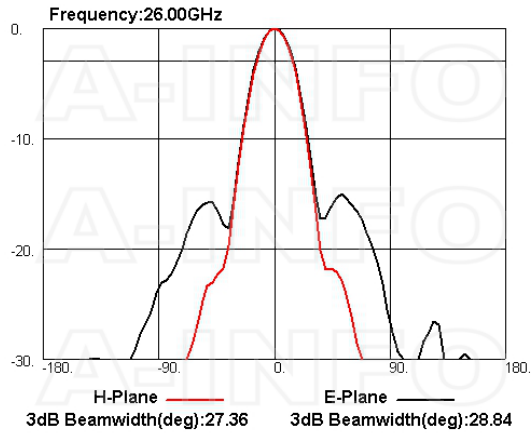

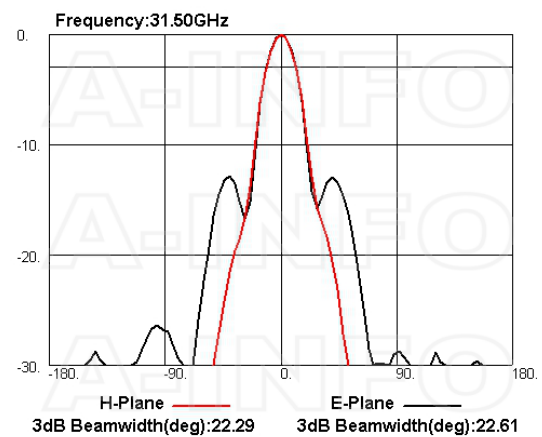
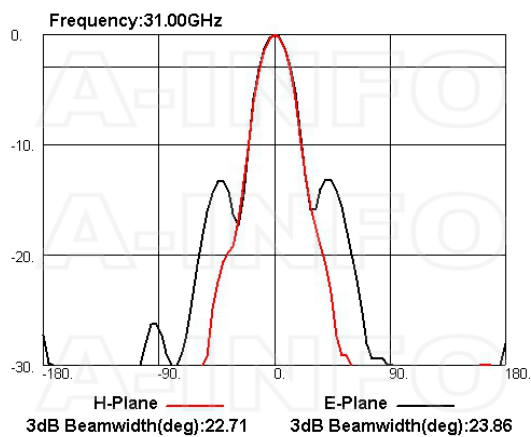
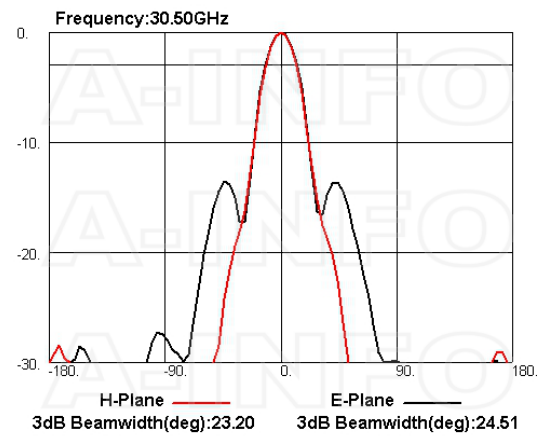
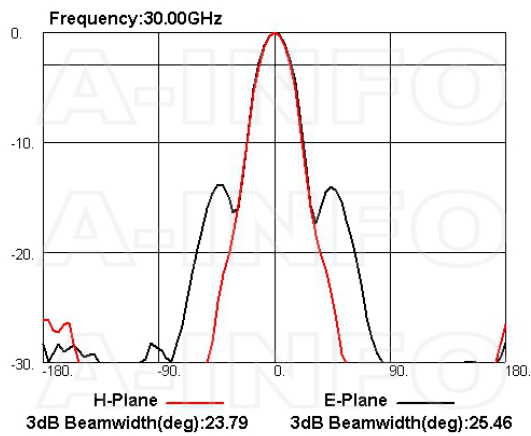
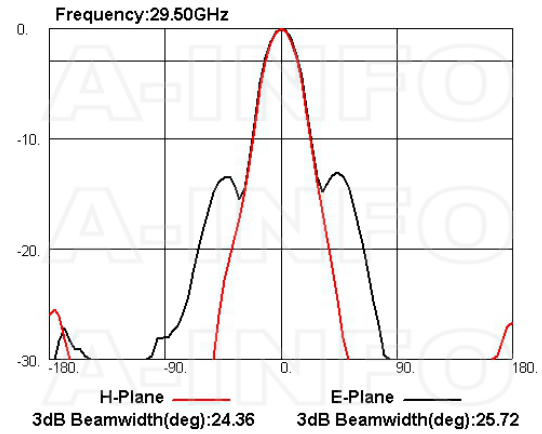
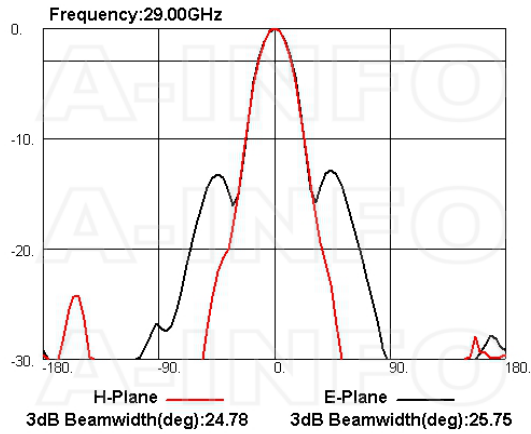

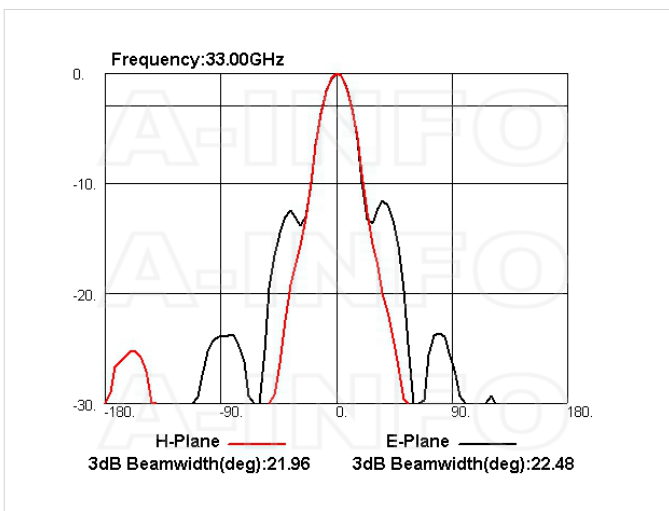
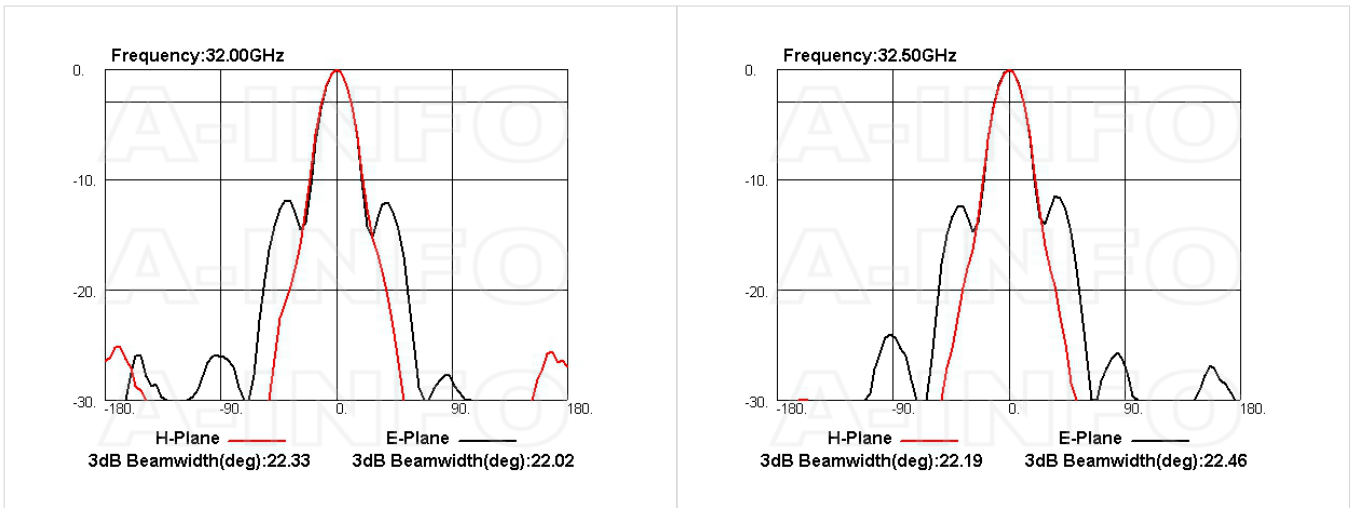

Related Products



LB-34-10-C-MB Round Type Mounting Bracket



LB-34-10-C-MBL L Type Mounting Bracket



LB-34-10-C-MA Stinger Type Mounting Bracket



Tripod_15Kg Al Alloy Tripod



3033HL Wooden Tripod



3033QM Wooden Tripod
Metalfree



Carrying Case_LB-34-15-C Al
Alloy Carrying Case



2.92M-2.92M-A050-500 Flexible
Cable Assembly 500mm DC-
40GHz 2.92mm Male to 2.92mm
Male



2.92M-2.92M-A050-1000 Flexible
Cable Assembly 1000mm DC-
40GHz 2.92mm Male to 2.92mm
Male



2.92M-2.92M-A050-1500 Flexible
Cable Assembly 1500mm DC-
40GHz 2.92mm Male to 2.92mm
Male



2.92M-2.92M-A050-2000 Flexible
Cable Assembly 2000mm DC-
40GHz 2.92mm Male to 2.92mm
Male



2.92M-2.92M-A050-3000 Flexible
Cable Assembly 3000mm DC-
40GHz 2.92mm Male to 2.92mm
Male



2.92M-2.92M-A050-5000 Flexible
Cable Assembly 5000mm DC-
40GHz 2.92mm Male to 2.92mm
Male



2.92M-2.92M-A050-10000
Flexible Cable Assembly
10000mm DC- 40GHz 2.92mm
Male to 2.92mm Male

Similar Products



LB-34-15-A Standard Gain Horn
Antenna 22-33GHz 15dB Gain
Rectangular Waveguide Interface

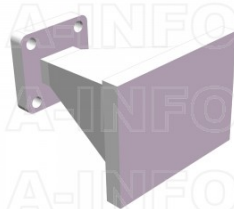

LB-34-15-ASPO Standard Gain
Horn Antenna 22-33GHz 15dB
Gain Rectangular Waveguide
Interface

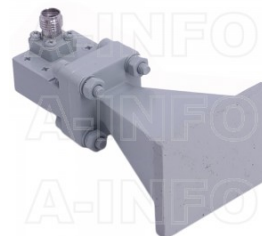

LB-34-15-C-KFSPO Standard Gain
Horn Antenna 22-33GHz 15dB
Gain 2.92mm Female

About this Datasheet

<ul style="list-style-type: none"> ● Product Information Product Link: https://www.ainfoinc.com/lb-34-15-c-kf-standard-gain-horn-antenna-22-33-ghz-15db-gain-2-92mm-female Data subject to change without notice. © A-INFO INC. 2023. All Rights Reserved 	<ul style="list-style-type: none"> ● Contact Us Address:dd 60 Tesla, Irvine, CA 92618, USA Website: www.ainfoinc.com Email: sales@ainfoinc.com 	<ul style="list-style-type: none"> ● Phone & Fax Phone: +1-949-639-9688 +1-949-639-9608 Fax: +1-949-639-9670
---	---	--